

BOVENAANZICHT

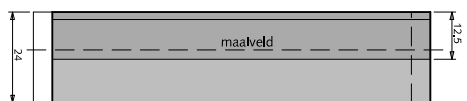

AANZICHT

①

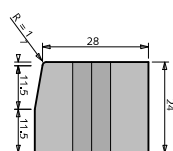

ZIJAAANZICHT

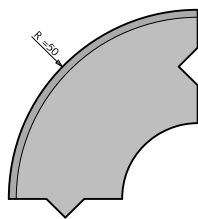

②

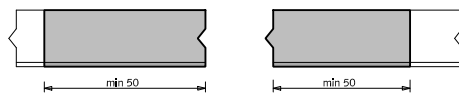

GEZAAGDE BAND

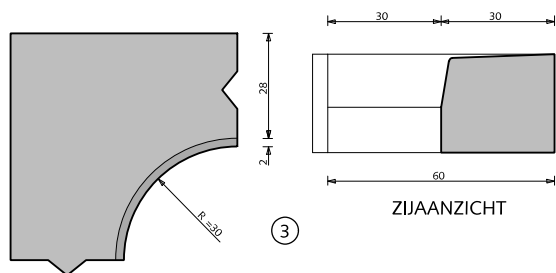

ZIJAAANZICHT

③

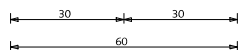

BOVENAANZICHT



BOVENAANZICHT

⑤

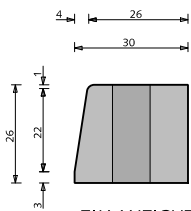

ZIJAAANZICHT

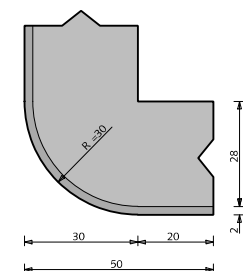

BOVENAANZICHT

④

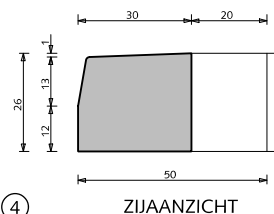

ZIJAAANZICHT

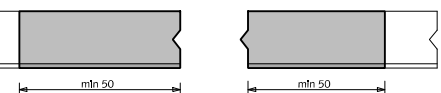

GEZAAGDE BAND

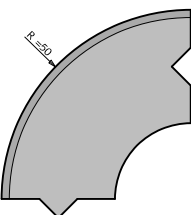

⑥

MATERIELEN TROTTOIRBANDEN

- ① Trottoirband 28/30x24x100cm, antraciet
- ② Bochtband 28/30cm, antraciet
- ③ Hoekblok 28/30cm 90° inwendig r=30cm antraciet
- ④ Hoekblok 28/30cm 90° uitwendig r=30cm antraciet
- ⑤ Hoge trottoirband 26/30x26x100cm, antraciet
- ⑥ Bochtband 28/30cm, antraciet

alle maten in cm
zie ook website fabrikanten in verband met
toepasbare bochtstukken en mogelijke aanpassingen



Gemeente Den Haag

december 2013

HOFSTADKWALITEIT

blad: HMA 01

HANDBOEK OPENBARE RUIMTE
STANDAARD WEGENBOUWDETAILS



MATERIALEN OPSLUITBAND

- ① Opsluitband 10x20x100cm antraciet
- ② Hoekstuk 10/20cm 90° in-/uitwendig antraciet
- ③ Hoekstuk 10/20cm 135° in-/uitwendig antraciet
- ④ Bochtbanden 10/20cm uitwendig antraciet

alle maten in cm
zie ook website fabrikanten in verband met
mogelijke aanpassingen

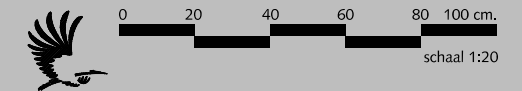

Gemeente Den Haag

december 2013

HOFSTADKWALITEIT

blad: HMA 02

HANDBOEK OPENBARE RUIMTE
STANDAARD WEGENBOUWDETAILS

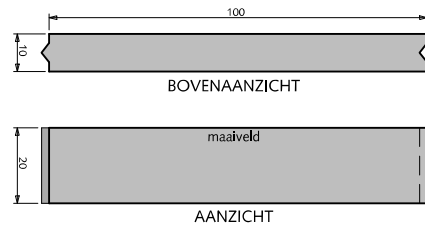

①

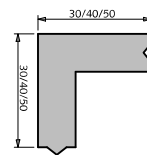
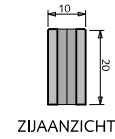

②

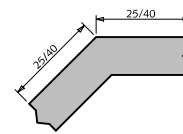

③

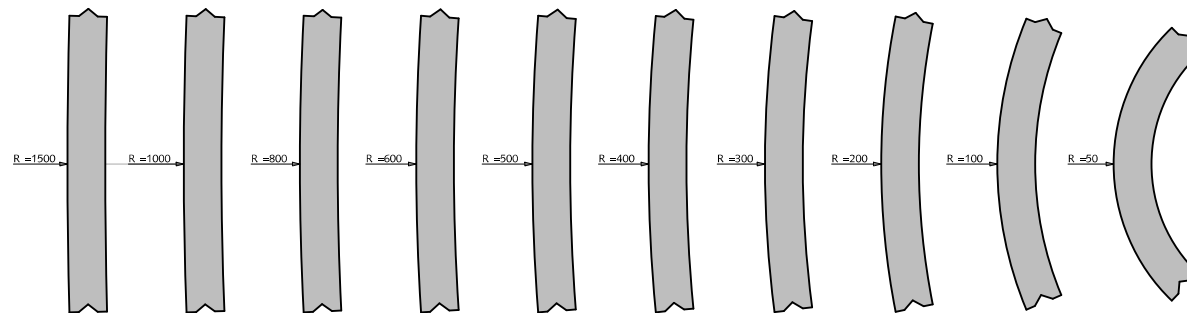

④

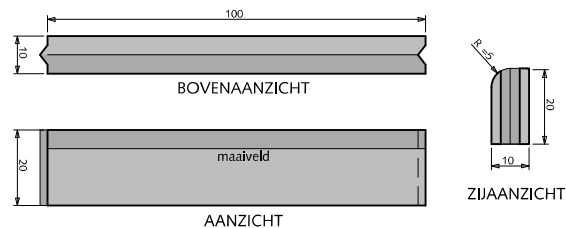

①

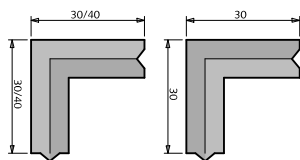

②

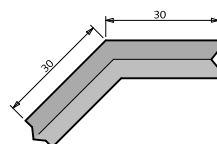

③

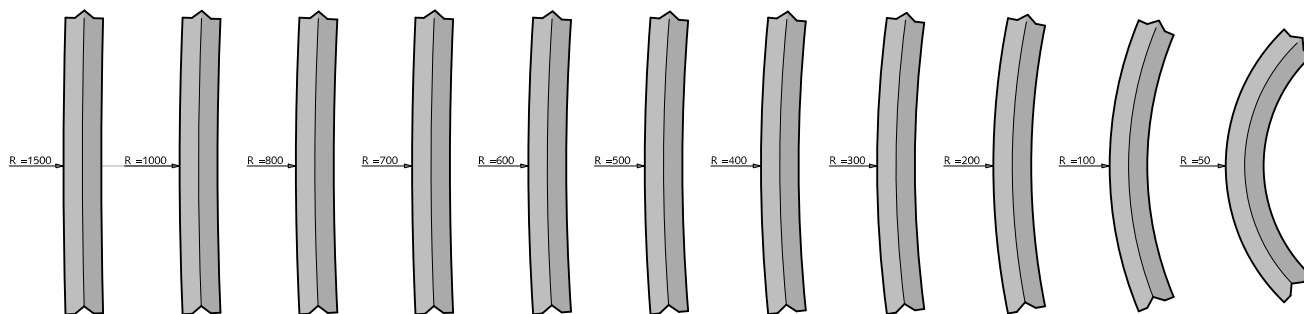

④

MATERIALEN GAZONBAND

- ① Gazonband 10x20x100cm antraciet
- ② Hoekstuk 10/20cm 90° in-/uitwendig antraciet
- ③ Hoekstuk 10/20cm 135° in-/uitwendig antraciet
- ④ Bochtbanden 10/20cm uitwendig antraciet

zie ook website frabrikanten in verband met
mogelijke aanpassingen



Gemeente Den Haag

HOFSTADKWALITEIT

HANDBOEK OPENBARE RUIMTE
STANDAARD WEGENBOUWDETAILS



december 2013

blad: HMA 03

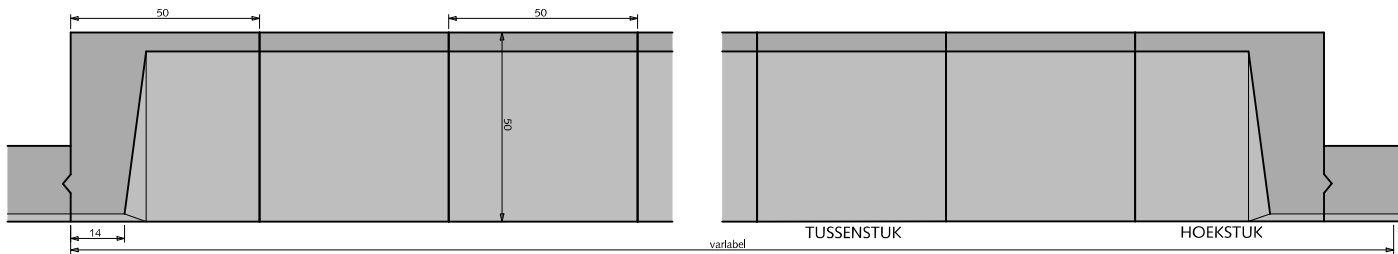

①

Strek(rol)laag aansluitende bestrating altijd vlak leggen



ZIJAAANZICHT

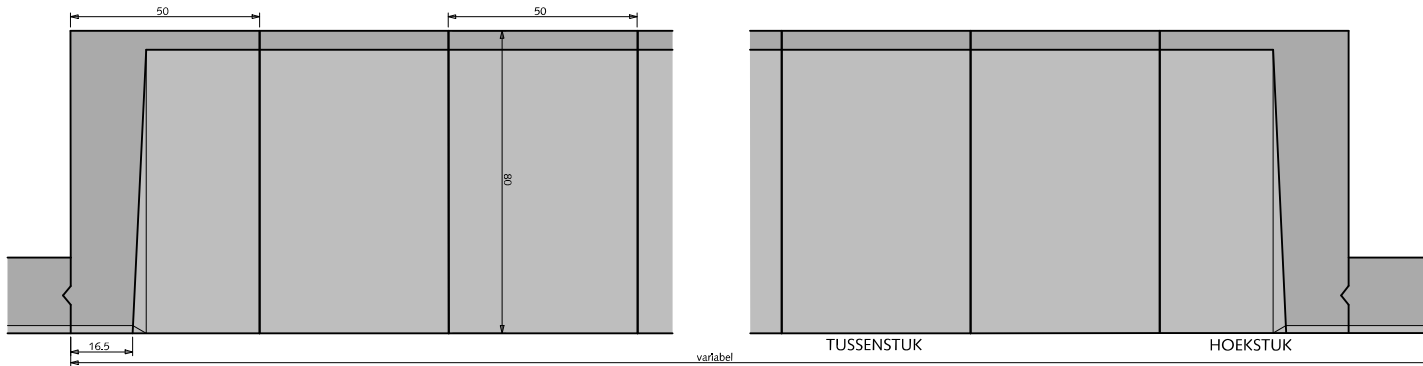
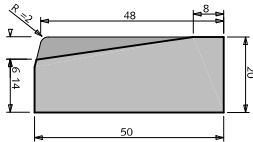

②

Strek(rol)laag aansluitende bestrating altijd vlak leggen

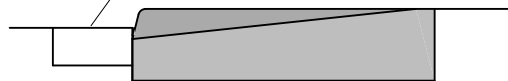

ZIJAAANZICHT

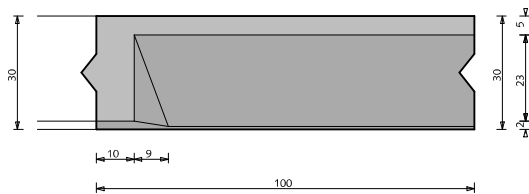
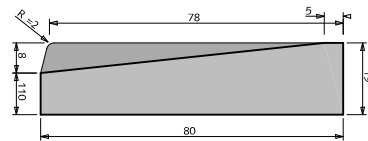

BOVENAANZICHT

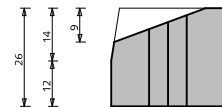

ZIJAAANZICHT

③

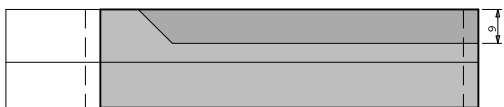

VOORAANZICHT

MATERIELEN INRITBANDEN / INRITBLOKKEN

- ① Inritblokken 14/20x50x50cm antraciet
- ② Inritblokken 11/19x80x50cm antraciet, toepassen indien schrikstrook te smal is voor inritblokken van 80cm diep
- ③ Inritband 28/30x26x100cm antraciet

alle maten in cm
zie ook website fabrikanten in verband met mogelijke aanpassingen



Gemeente Den Haag

december 2013

HOFSTADKWALITEIT

blad: HMA 04

HANDBOEK OPENBARE RUIMTE
STANDAARD WEGENBOUWDETAILS

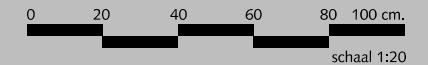

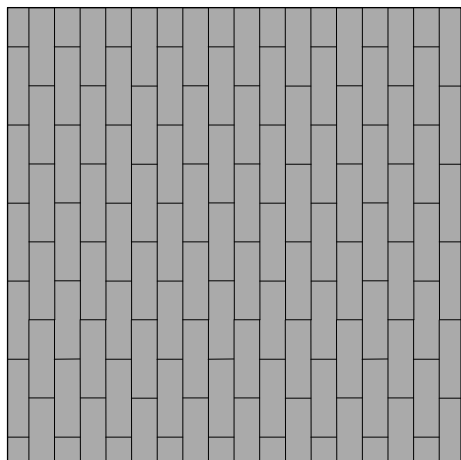

PARKEREN

①

HALFSTEENSVERBAND

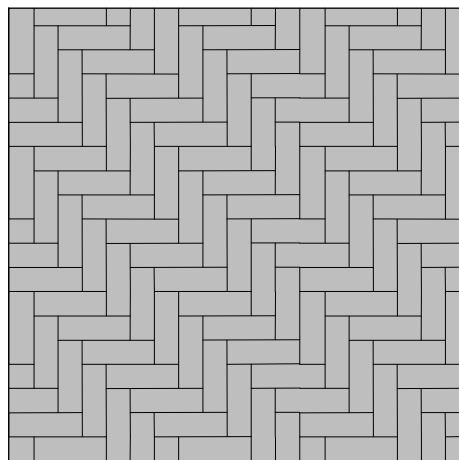

PARKEREN

②

ELLEBOOGVERBAND

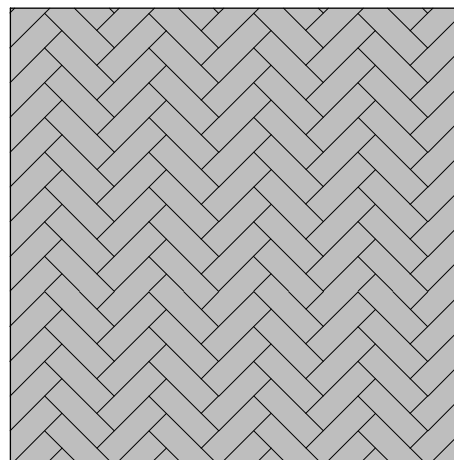

RIJWEG

③

KEPERVERBAND

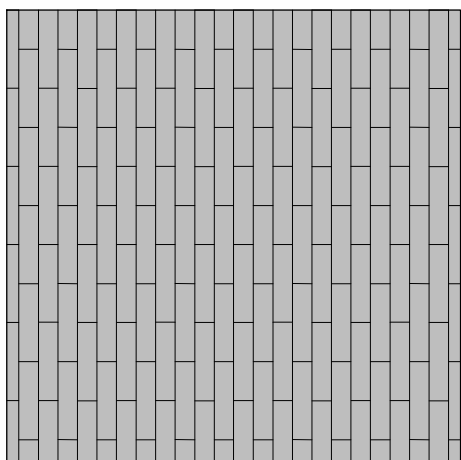

TROTTOIR <3m
FIETSPAD
SCHIKSTROOK

④

HALFSTEENSVERBAND

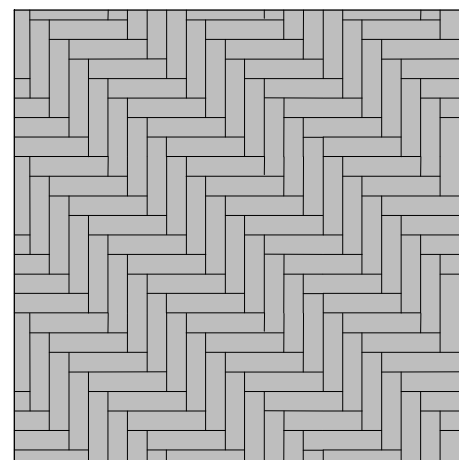

TROTTOIR >3m

⑤

ELLEBOOGVERBAND



RIJWEG
FIETSPAD

⑥

MATERIALEN VERHARDINGEN

- ① Straatbaksteen dikformaat mangaan, bij hoge intensiteit elleboogverband toepassen
- ② Straatbaksteen dikformaat mangaan
- ③ Straatbaksteen dikformaat mangaan
- ④ Straatbaksteen waalformaat mangaan
- ⑤ Straatbaksteen waalformaat mangaan
- ⑥ Asphalt zwart of rood (RAL 3009)

Bij een trottoirbreedte van minder dan 3.00 m halfsteensverband toepassen, bij trottoirs breder dan 3.00 m elleboogverband toepassen.

zie ook website frabrikanten in verband met mogelijke aanpassingen



Gemeente Den Haag



schaal 1:20

december 2013

HOFSTADKWALITEIT

blad: HMA 05

HANDBOEK OPENBARE RUIMTE
STANDAARD WEGENBOUWDETAILS

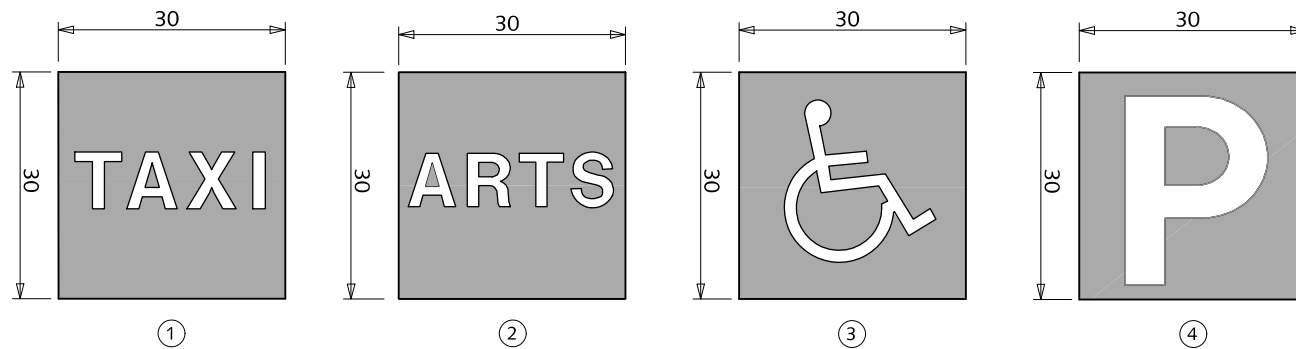

①

②

③

④

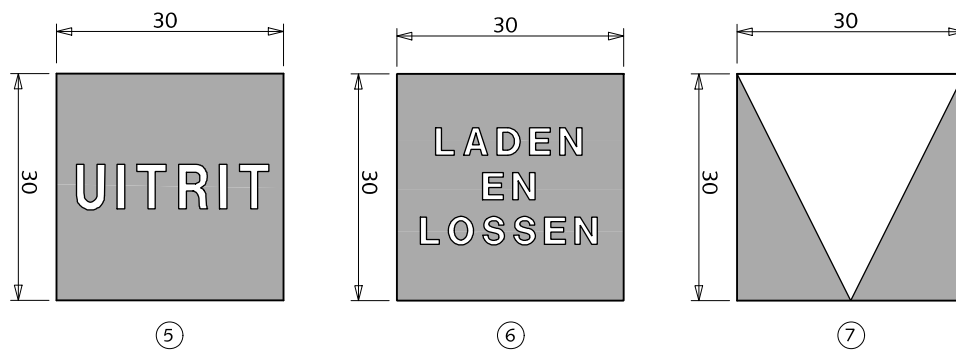

⑤

⑥

⑦

MATERIALEN TEKST- EN SYMBOOLTEGELS

- ① Betontegel 30x30x6cm antraciet met witte tekst "TAXI"
- ② Betontegel 30x30x6cm antraciet met witte tekst "ARTS"
- ③ Betontegel 30x30x6cm antraciet met witte symbool "ROLSTOEL"
- ④ Betontegel 30x30x6cm antraciet met witte tekst "p"
- ⑤ Betontegel 30x30x6cm antraciet met witte tekst "UITRIT"
- ⑥ Betontegel 30x30x6cm antraciet met witte driehoek "HAAIENTAND"
- ⑦ Betontegel 30x30x6cm antraciet met witte tekst "LADEN EN LOSSEN"

Tekst- en symbooltegels hebben geen juridische status. De tegels ondersteunen de bebording (terughoudend toepassen).



Gemeente Den Haag



schaal 1:10

december 2013

HOFSTADKWALITEIT

blad: HMA 06

HANDBOEK OPENBARE RUIMTE
STANDAARD WEGENBOUWDETAILS

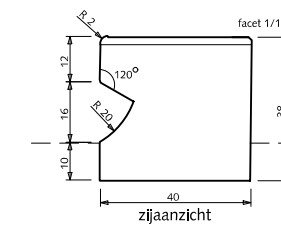
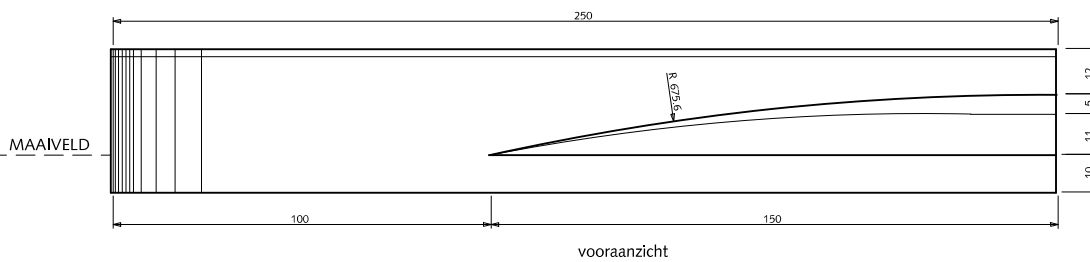
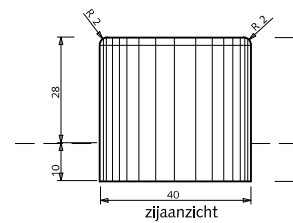
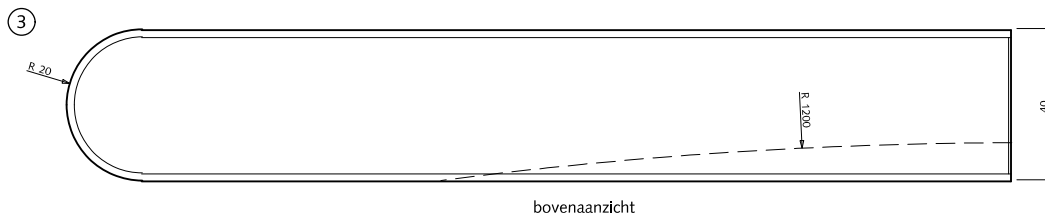
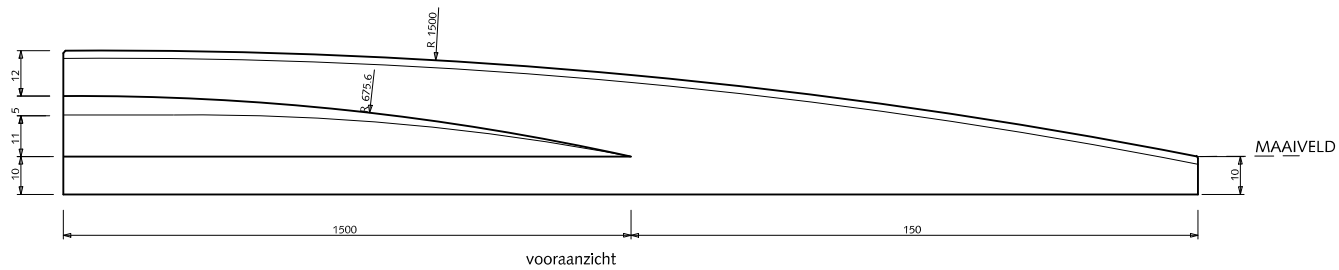
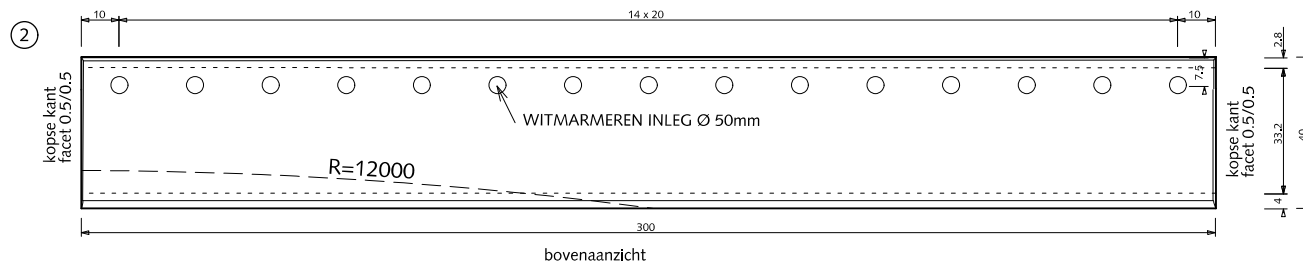
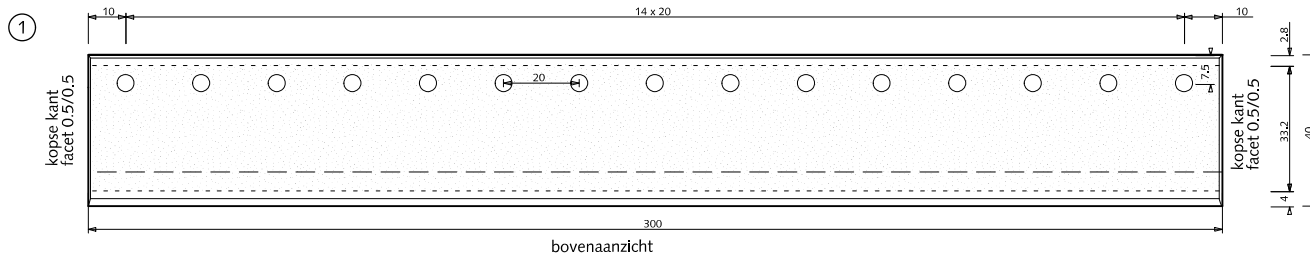

MATERIALEN TRAMHALTEBAND

- ① Tussenstuk 300x40x40cm antraciet
- ② Eindstuk aansluitend op maaiveld 300x40cm, antraciet
- ③ Eindstuk met afronding 250x40x38cm antraciet

alle maten in cm



Gemeente Den Haag

december 2013

HOFSTADKWALITEIT

blad: HMA 07

HANDBOEK OPENBARE RUIMTE
STANDAARD WEGENBOUWDETAILS

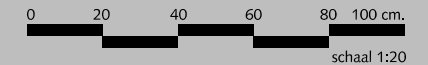

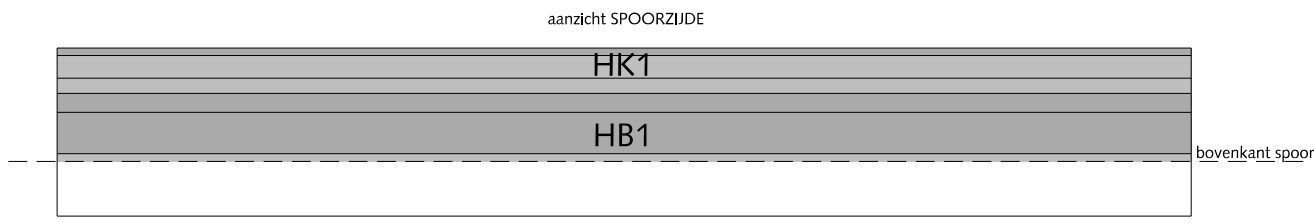
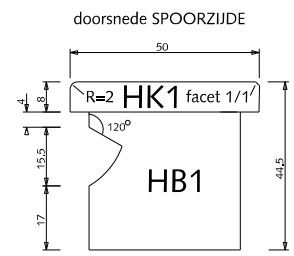
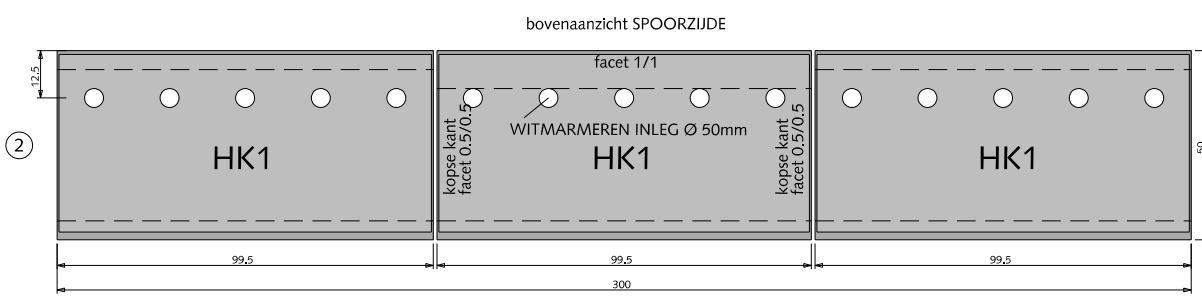
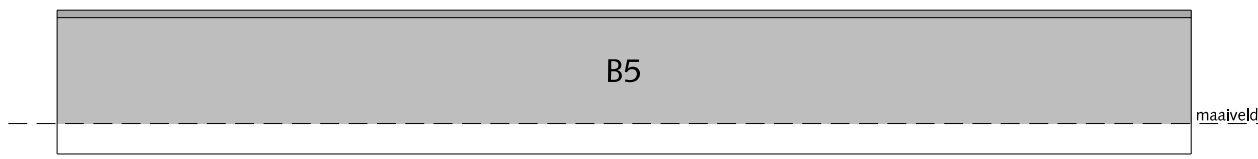
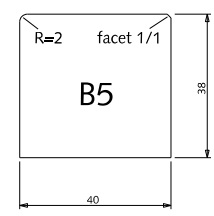
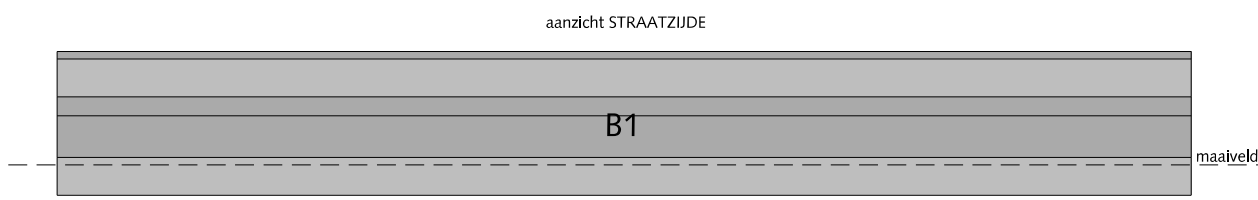
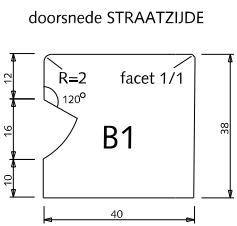
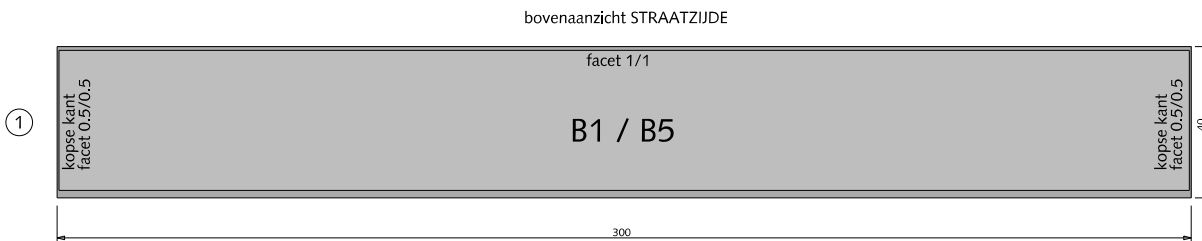

MATERIALEN

NRR-PERRONBANDEN

tussenstukken met verstelbare bovenplaat

(bestek 2012.091.108)

- ① Tussenstuk B1 / B5 300x40x38cm antraciet
- ② Tussenstuk HK1 99.5x5x8cm antraciet

alle maten in cm



Gemeente Den Haag

december 2016

HOFSTADKWALITEIT

blad: RMA 07

HANDBOEK OPENBARE RUIMTE
STANDAARD WEGENBOUWDETAILS

①

bovenaanzicht STRAATZIJDE

doorsnede STRAATZIJDE

aanzicht kopzijde

maaiveld

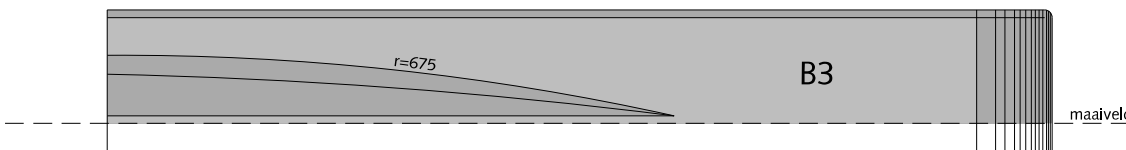
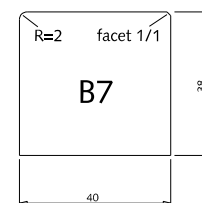
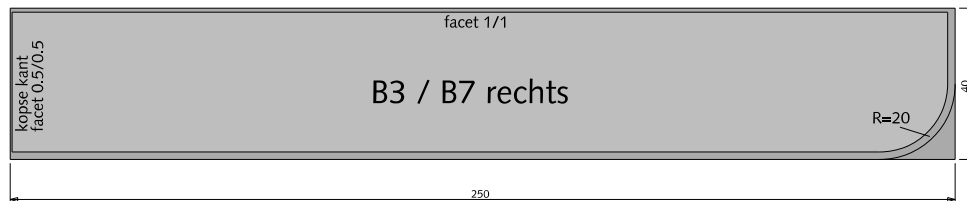
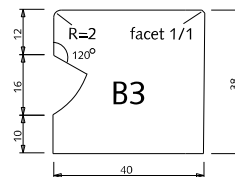
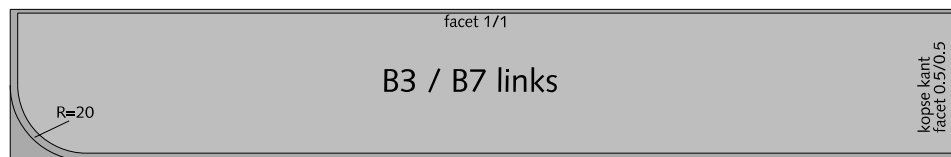

②

bovenaanzicht STRAATZIJDE

doorsnede STRAATZIJDE

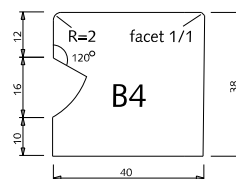
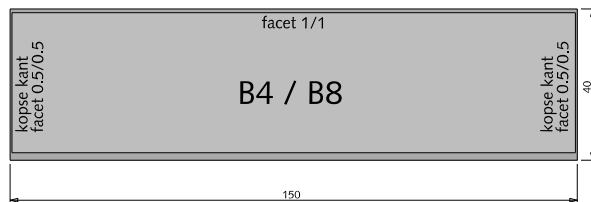

aanzicht STRAATZIJDE

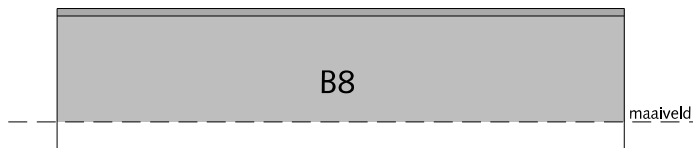
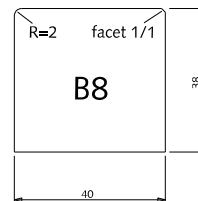
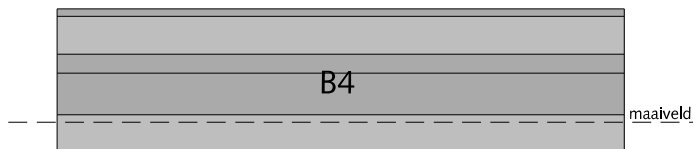

MATERIALEN

NRR-PERRONBANDEN

einstukken straatzijde

(bestek 2012.091.108)

- ① Einstuk B3 / B7 250x40x38cm antraciet
- ② Tussenstuk B4 / B8 150x40x38cm antraciet

alle maten in cm



0 20 40 60 80 100 cm.

schaal 1:20

Gemeente Den Haag

december 2016

HOFSTADKWALITEIT

blad: RMA 08

HANDBOEK OPENBARE RUIMTE
STANDAARD WEGENBOUWDETAILS

①
bovenaanzicht SPOORZIJD

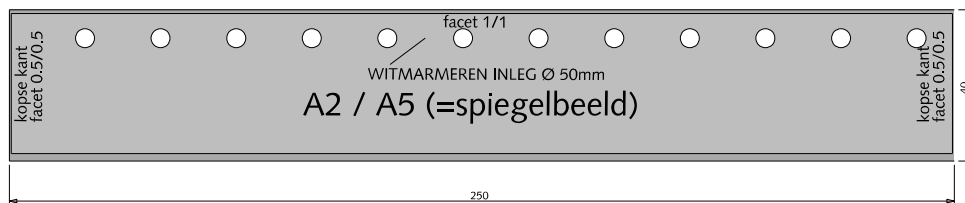

aanzicht SPOORZIJD

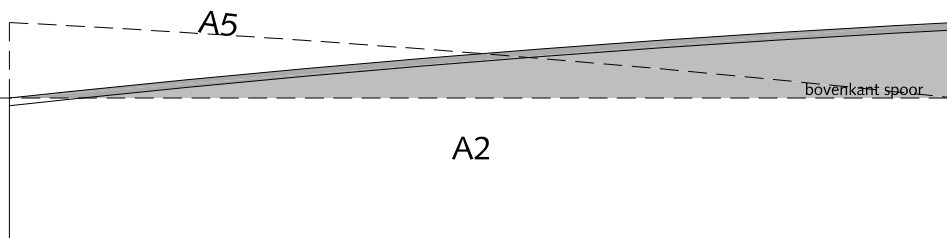

aanzicht kopzijde

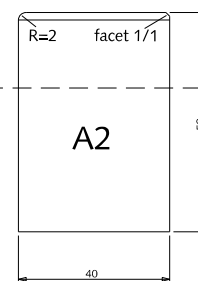

aanzicht kopzijde

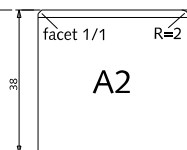

②
bovenaanzicht SPOORZIJD

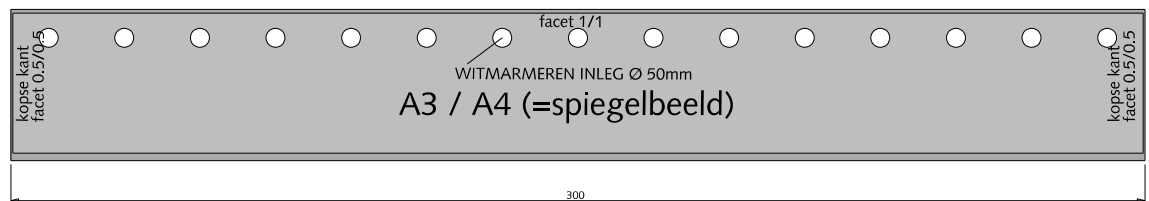

aanzicht SPOORZIJD

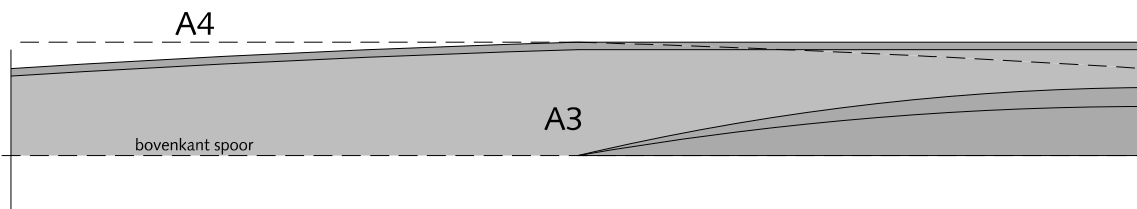

aanzicht kopzijde

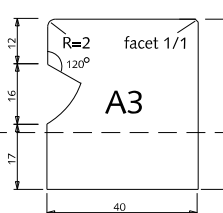

aanzicht kopzijde

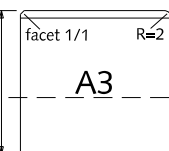

MATERIALEN

NRR-PERRONBANDEN

oploopstukken lange oploop spoorzijde

(bestek 2012.091.108)

- ① Oploopstuk A2 / A5 250x40x38/58cm antraciet
- ② Oploopstuk A3 / A4 300x40x38/45cm antraciet

alle maten in cm



Gemeente Den Haag

HOFSTADKWALITEIT

HANDBOEK OPENBARE RUIMTE
STANDAARD WEGENBOUWDETAILS



schaal 1:20

december 2016

blad: RMA 09

①

bovenaanzicht SPOORZIJD

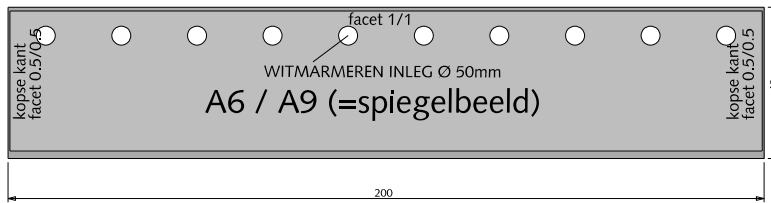

aanzicht SPOORZIJD

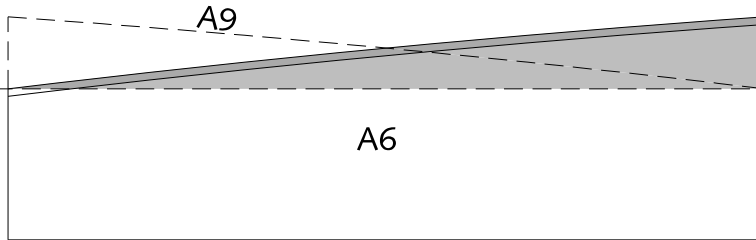

aanzicht kopzijde

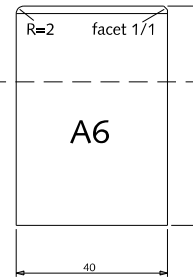

aanzicht kopzijde

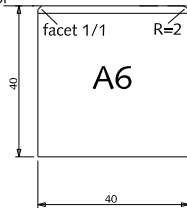

bovenkant spoor

②

bovenaanzicht SPOORZIJD

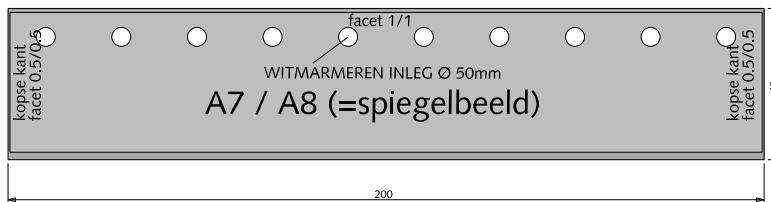

aanzicht SPOORZIJD

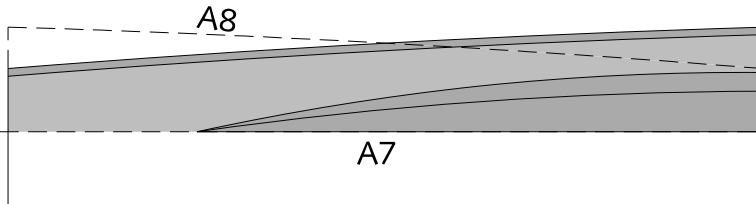

aanzicht kopzijde

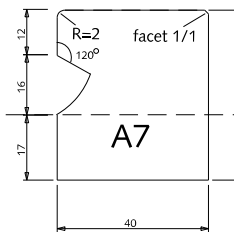

aanzicht kopzijde

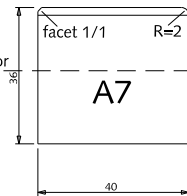

bovenkant spoor

MATERIALEN

NRR-PERRONBANDEN

oploopstukken korte oploop spoorzijde (bestek 2012.091.108)

- ① Oploopstuk A6 / A9 200x40x40/59cm antraciet
- ② Tussenstuk A7 / A8 200x40x36/45cm antraciet

alle maten in cm

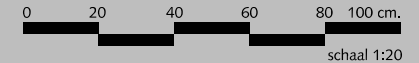

Gemeente Den Haag

december 2016

HOFSTADKWALITEIT

blad: RMA 10

HANDBOEK OPENBARE RUIMTE
STANDAARD WEGENBOUWDETAILS

①
bovenaanzicht STRAATZIJDE

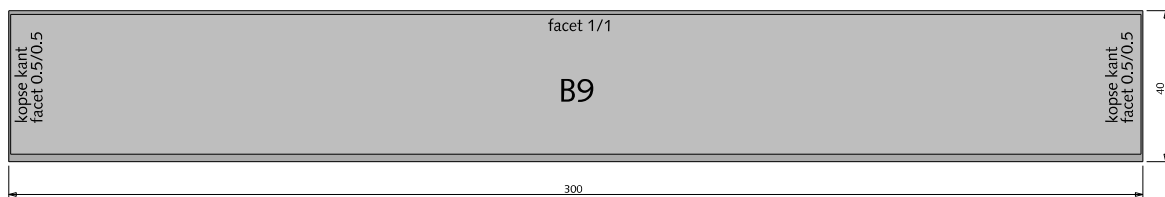

aanzicht STRAATZIJDE

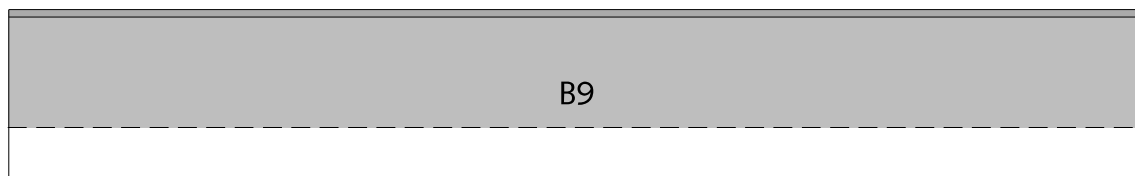

doorsnede

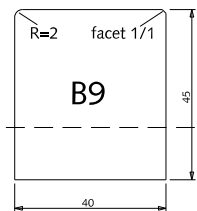

②
bovenaanzicht SPOORZIJDE

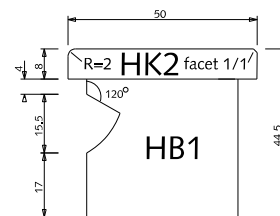
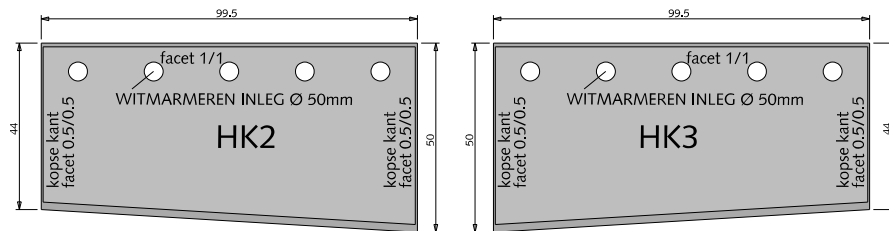

③
bovenaanzicht SPOORZIJDE

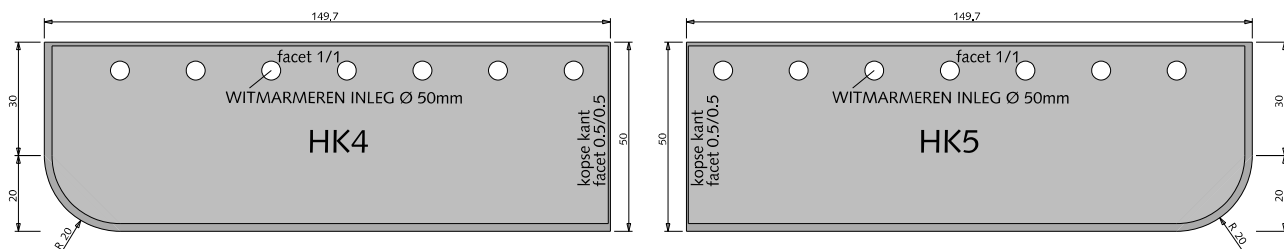

MATERIALEN NRR-PERRONBANDEN halte eindstukken (bestek 2012.091.108)

- ① Halte eindstuk B9 300x40x45cm antraciet
- ② Eindstuk HK2 / HK3 50/44x50x8cm antraciet
- ③ Eindstuk HK4 / HK5 149.75x50x8cm antraciet

alle maten in cm



Gemeente Den Haag

december 2016

HOFSTADKWALITEIT

blad: RMA 11

HANDBOEK OPENBARE RUIMTE
STANDAARD WEGENBOUWDETAILS

①
bovenaanzicht STRAATZIJDE

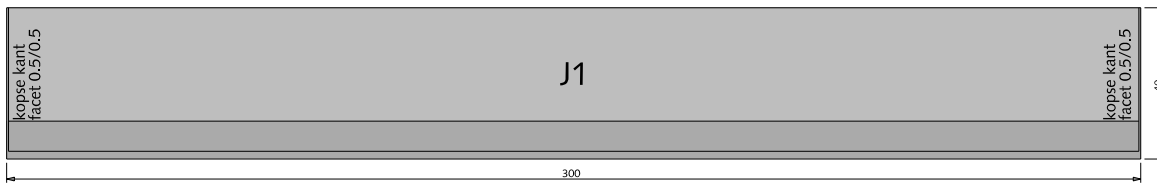

aanzicht STRAATZIJDE

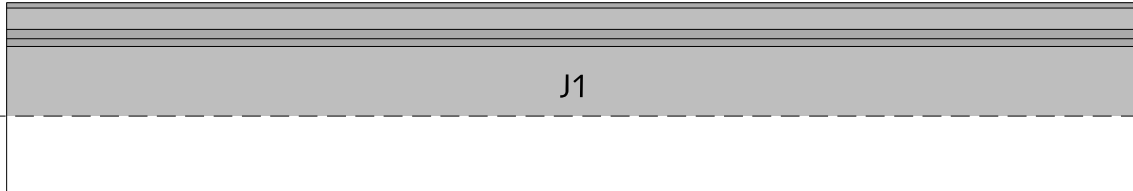

maaiveld

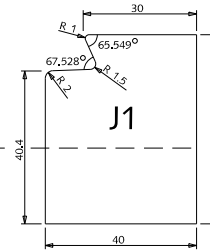

②
bovenaanzicht STRAATZIJDE

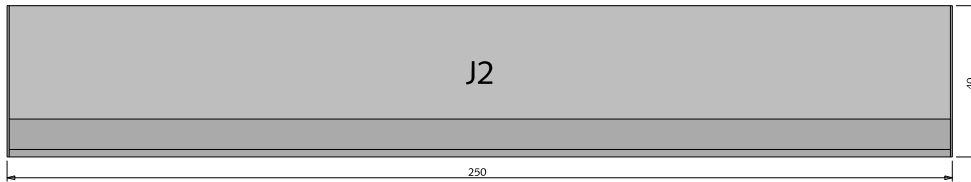

aanzicht STRAATZIJDE

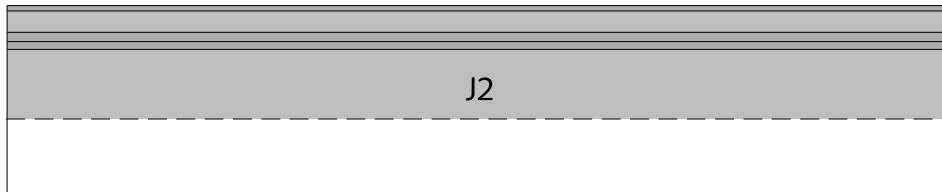

maaiveld

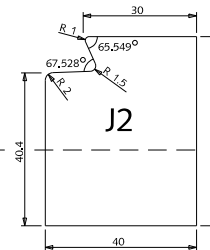

③
bovenaanzicht STRAATZIJDE

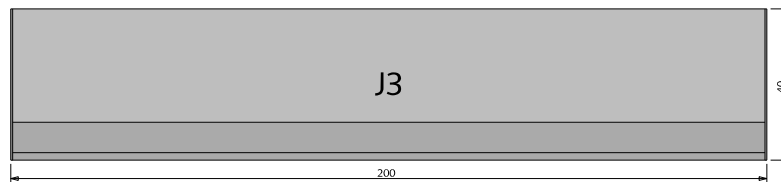

aanzicht STRAATZIJDE

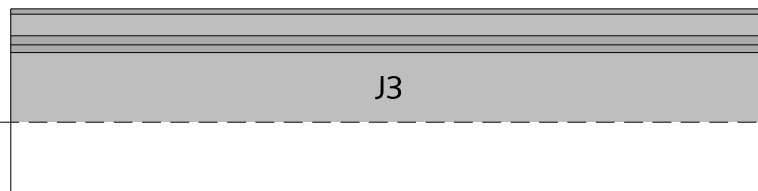

maaiveld

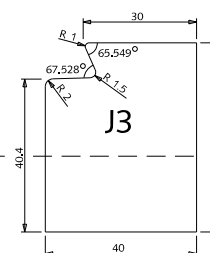

MATERIALEN

NRR-PERRONBANDEN

tussenstukken J-elementen

(bestek 2012.091.108)

- ① Tussenstuk J1 300x40x50cm antraciet
- ② Tussenstuk J2 250x40x50cm antraciet
- ③ Tussenstuk J3 200x40x50cm antraciet

alle maten in cm



0 20 40 60 80 100 cm.

schaal 1:20

Gemeente Den Haag

december 2016

HOFSTADKWALITEIT

blad: RMA 12

HANDBOEK OPENBARE RUIMTE
STANDAARD WEGENBOUWDETAILS